

Vehicle Scales



POWERCELL™ PDX™

Load Cell

Unequalled Reliability

Highest Accuracy

Predictive Diagnostics

Proven Performance



Advanced Technology
Takes Reliability to a New Level

METTLER TOLEDO

POWERCELL™ PDX™ Load Cell

Reliability to Protect Your Profits

POWERCELL PDX digital load cells protect your profits by ensuring that your vehicle scale weighs accurately day in and day out. Their predictive diagnostics constantly monitor your scale to give you peace of mind and reduced operating costs.

Unequalled Reliability

Every minute that your scale weighs inaccurately or doesn't weigh at all costs you money. POWERCELL load cells have withstood the most extreme forces of nature for more than 20 years. The new POWERCELL PDX load cell takes this reliability to a new level and includes predictive diagnostics to keep you continuously informed about your scale's performance:

- Weighing errors
- Overloading
- Environmental conditions
- Network health
- Load cell voltages
- Enclosure integrity

With other load cell technologies, problems can go undetected for long periods. Weighing errors add up until a load cell fails and shuts down your scale. The POWERCELL PDX load cell eliminates these concerns and gives you a proactive way to keep your scale running:

- Assuring you that your scale is working properly.
- Alerting you to potential problems so they can be prevented.
- Pinpointing the source of a problem for quick intervention.

100% Protection

against the forces that can eat into your profits



Snow and Ice



Lightning



Extreme Temperatures



Rust and Corrosion



Water and Flood



Radio Frequency Interference



Rodents



Physical Damage

We Didn't Just Think Outside the Box

We Got Rid of the Box

Simplified Communication

POWERCELL PDX load cells connect to one another in a simple network, eliminating high-maintenance junction boxes and costly totalizers. In other systems, sensitive electronics are located in junction boxes, which are prone to failure and hard to seal against moisture. With POWERCELL PDX load cells, electronic components are protected inside the hermetically sealed load cell enclosures.



Eliminating junction boxes eliminates a common cause of scale failure.

Load Cell Cables

Load cell cables are often weak links in a network. POWERCELL PDX load cells use heavy-duty cables protected by braided stainless steel sheathing. The cables are designed to guarantee the integrity of the weight signal, protecting against radio frequency interference and damage caused by moisture, rodents, and machinery.



Double-shielded stainless steel cable and submersible connector.

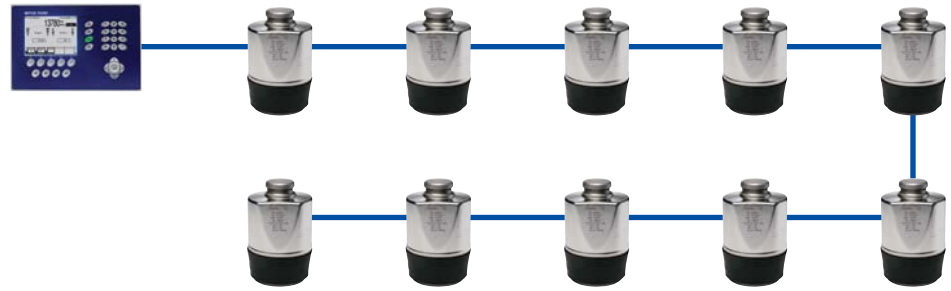

POWERCELL PDX Digital Load Cell Network (No Junction Boxes)

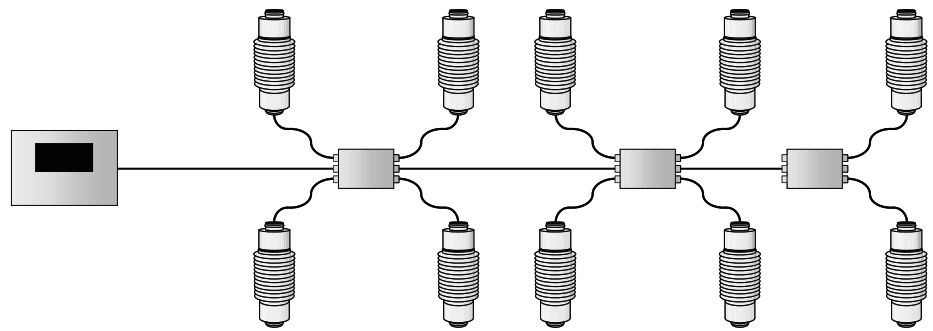

Conventional Load Cell Wiring (Junction Boxes Required)



Cable connections form a watertight seal even when submersed.

POWERCELL PDX load cell cables and connectors are watertight, effectively sealing the entire network against moisture to IP68 standards (submersible). The connectors use the same robust, highly reliable design found in the most harsh and wet military and medical applications, where performance is a matter of life and death.

The quick-connect design makes it easy to replace individual load cells or cables. There is no need to recalibrate the scale if a cable is replaced. Analog load cells have integral cables, requiring the replacement of both the load cell and cable if either is damaged. This significantly increases repair costs and downtime.



POWERCELL PDX load cells have surpassed rigorous testing for high-pressure spraying and water submersion.

Complete Protection Against Lightning Strikes

A lightning strike can put a vehicle scale out of service in an instant. Lightning damage can be very costly, requiring the replacement of unprotected electronic equipment. Even if a warranty covers repair costs, you still face the cost of the business you lose every day that your scale is not operating.

StrikeShield™ Protection

METTLER TOLEDO provides complete protection against lightning damage. StrikeShield lightning protection is designed to be the main line of defense for your entire vehicle scale system: load cells, cables, and terminals. It uses surge protectors and a single-point ground to keep your scale up and running by preventing electrical damage.

Each POWERCELL PDX load cell has its own built-in lightning protection. If a voltage surge occurs in the cables, the load cell's surge protection circuitry redirects the current to ground. All internal electronic components are fully protected from damage.

Independently Tested

The POWERCELL PDX system offers real proof of its lightning protection capabilities. The average lightning strike is 30,000 amperes. The POWERCELL PDX load cell system has been proven in independent testing to survive multiple lightning strikes up to 80,000 amperes. That's more than twice the destructive power of the average lightning strike. No other scale manufacturer has had its system as thoroughly tested by independent laboratories. The POWERCELL PDX load cell meets the toughest standards for protection against lightning (International Electrotechnical Commission IEC 62305-1).



POWERCELL PDX load cell under laboratory testing of a simulated lightning strike.

METTLER TOLEDO Weighs in the World's Most Extreme Climates



Antarctica



Deserts



Siberia



Tropics

Proven Performance

With nearly a million in service worldwide, the METTLER TOLEDO line of POWERCELL load cells has demonstrated the ability to weigh accurately while standing up to the toughest environments and the most unforgiving climates. From the frozen polar regions to the scorching heat of the desert and the wet conditions of the tropics, POWERCELL load cells have a proven history of accurate and reliable weighing performance.

Innovative Design Delivers a Clear Advantage

The POWERCELL PDX digital load cell provides many advantages over conventional analog load cells, hydraulic load cells, sectional controllers, and digital junction boxes. It has a robust design and innovative features that take vehicle weighing to a new level of reliability. The load cell's on-board microprocessor

provides you with the most accurate scale possible by continually adapting to changing external factors such as temperature, nonlinearity, hysteresis, voltage variation, and scale creep. The built-in predictive diagnostics capabilities are unequalled in the weighing industry.

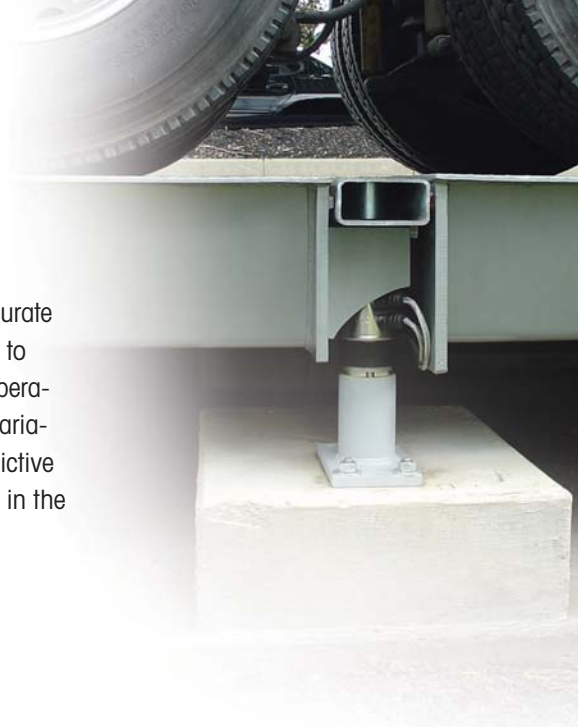

Profitability Protected with Highest Weighing Accuracy

If you buy and sell goods by weight, the accuracy of your vehicle scale is crucial to your profitability. Even vehicle scales that meet legal-for-trade requirements can make costly weighing errors. The more vehicles you weigh, the more the losses add up.

POWERCELL PDX load cells protect your profits by providing weighing accuracy you can count on. What makes scales with POWERCELL PDX load cells more accurate?

Each POWERCELL PDX load cell uses an on-board microprocessor to monitor internal and external influences that affect weighing accuracy. By compensating for changes in those influences, the microprocessor enables each load cell to provide accurate weights in any environment.

Internal/external influences:

- Temperature
- Voltage variation
- Non-linearity
- Hysteresis
- Creep
- Instability
- Zero change
- Sensitivity change

Because analog load cells do not effectively compensate for these influences, they produce a significant number of vehicle weighing errors that exceed 60 lb / 30 kg.

POWERCELL PDX load cells maintain weighing accuracy by alerting you to problems within the network. If a problem occurs, it can be fixed quickly. With a conventional analog load cell system, you never know when a load cell or cable fails. The analog scale can provide inaccurate weights indefinitely, causing you to lose money and customers.

Accuracy Comparison: POWERCELL vs. Analog Load Cells

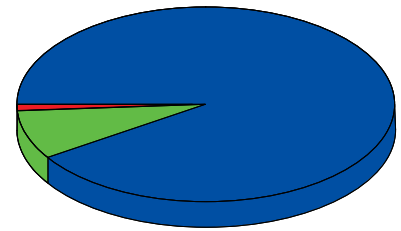

POWERCELL Load Cells

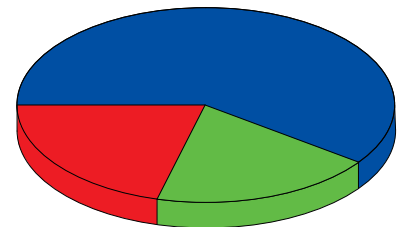

Analog Load Cells

- Error 0-20 lb / 0-10 kg
- Error 40-60 lb / 20-30 kg
- Error >60 lb / >30 kg

This data is from randomly selected service reports compiled for scales from many different manufacturers.



POWERCELL PDX load cells are ideal for upgrading existing scales to improve weighing performance and simplify maintenance.

Breach Detection

In addition to its heavy-duty, hermetically sealed enclosure, the POWERCELL PDX load cell provides a second level of protection for its electronics. A built-in breach detection system alerts you if the enclosure is damaged by accidental puncture or tampering.

The breach detection system allows you to replace a load cell at the first sign of trouble, before moisture causes weighing errors or scale failure. With conventional load cells, a breached enclosure can go undetected for months while weighing errors eat into your profits until the scale eventually fails.

Unmatched Value

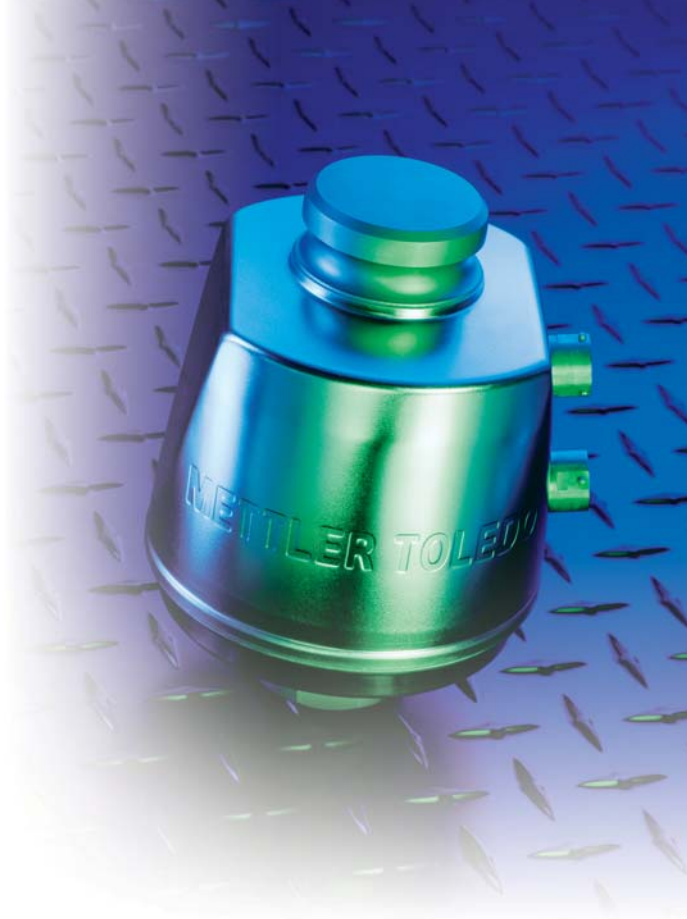

The POWERCELL PDX load cell offers a return on investment that no other load cell can match. When evaluating any scale, look at its total cost of ownership: initial costs + fixed costs + variable costs. Your scale's initial cost and regular maintenance are easy to plan for, but the cost of unplanned service

can be a real wild card. With its exceptional reliability and advanced diagnostics, the POWERCELL PDX load cell virtually eliminates the unplanned service costs that make other load cells a risky investment. It gives you unmatched value over the life of your scale.



| | |
|-----------------------|---|
| Initial Costs | <ul style="list-style-type: none"> ■ Purchase price of scale ■ Installation cost |
| Fixed Costs | <ul style="list-style-type: none"> ■ Calibration and certification ■ Regular maintenance |
| Variable Costs | <ul style="list-style-type: none"> ■ Weighing errors ■ Downtime ■ Emergency maintenance ■ Premature replacement |

POWERCELL PDX Loads Cells Outperform All Other Vehicle Scale Technologies

| Technology | Problems | POWERCELL PDX Advantages |
|--|--|---|
| Analog Load Cell  | <ul style="list-style-type: none"> ■ Weak analog signal: EMI/RFI causes weighing errors ■ No compensation for many external factors, which can lead to inaccurate weights ■ No advanced diagnostics ■ Moisture can penetrate integral cable, interfering with weak analog signal ■ Requires summing junction boxes that are hard to seal and prone to failure | <ul style="list-style-type: none"> ■ Strong digital signal provides accurate weighing ■ On-board microprocessor continually compensates for external factors to achieve highest accuracy ■ Predictive diagnostics ■ Quick-connect cable provides IP68 watertight connection to load cell ■ No junction boxes |
| Digital Junction Box or Sectional Controller  | <ul style="list-style-type: none"> ■ Weak analog signal between load cell and junction box ■ Junction boxes not hermetically sealed ■ Sensitive electronics located in junction box: Easily damaged by moisture | <ul style="list-style-type: none"> ■ Strong digital signal throughout entire scale network ■ No analog-to-digital converter boxes or gathering cards required ■ Electronics protected in hermetically sealed load cell enclosure |
| Hydraulic Load Cell System  | <ul style="list-style-type: none"> ■ Complex and expensive installation ■ Hydraulic fluid leaks cause weighing errors ■ Totalizer relies on weak analog signal ■ Hydraulic system is difficult to troubleshoot ■ Slow system response time can delay truck processing ■ Maintenance and repair are time-consuming | <ul style="list-style-type: none"> ■ Simple and inexpensive installation ■ No hydraulic fluid to leak ■ Strong digital signal ■ Predictive diagnostics simplify troubleshooting ■ Instant updates ■ Maintenance and repair are quick and easy |

POWERCELL™ PDX™ Load Cell

for Proactive Service

The POWERCELL PDX load cell system is designed for proactive service, alerting you to potential problems before they occur. It helps avoid problems and, if problems do occur, enables service technicians to make the right repairs the first time and make them quickly. Diagnostics log files record performance trends, allowing METTLER TOLEDO to determine quickly if preventive or repair service is required. With the POWERCELL PDX load cell system, time-consuming troubleshooting and parts swapping are replaced by prevention.



Quick-connect load cell cables are part of the secure, sealed POWERCELL PDX network.

| Features | Benefits |
|--------------------------|--|
| Robust Design | Prevents typical load cell system problems |
| Simplified Network | No junction boxes to cause failures |
| Lightning Protection | Prevents power-surge damage |
| Predictive Diagnostics | Predicts faults to avoid repair expense |
| Double-Shielded Cables | Prevents rodent or other costly damage |
| Breach Detection | Warns of potential load cell failures |
| Quick-Connect Cables | Rapid and secure connection/replacement |
| CAN bus Interface | Fast, proven communication and monitoring |
| Converts Existing Scales | Full advantages without expense of new scale |

Proactive maintenance plans perfectly complement the POWERCELL PDX load cell system to deliver unmatched reliability and longevity for your scale.

**OUR VEHICLE SCALES ARE BACKED BY THE
INDUSTRY'S FINEST SERVICE NETWORK AND
MOST POWERFUL 5 YEAR WARRANTY**

www.mt.com/powercell

For more information

Mettler-Toledo, Inc.

1900 Polaris Parkway
Columbus, Ohio 43240
Tel. (800) 786-0038
(614) 438-4511
Fax (614) 438-4900
Internet: www.mt.com

Specifications subject to change without notice
METTLER TOLEDO® is a registered trademark
of Mettler-Toledo, Inc.
Printed in USA.
VEH-3409-LIT



Produced in a
facility that is

